

# G LUM

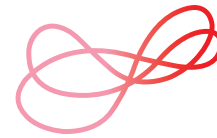

**LUMENIA  
INDUSTRIAL**

The G LUM LED light opens a new chapter in industrial lighting for various industrial applications, such as industrial facilities, garages, warehouses, and shopping centers. It is distinguished by an ultra-light, compact, and highly aesthetic design, thus allowing swift modernization of existing industrial lighting systems with considerable energy savings.



	G LUM
System efficacy	Up to 154 lm/W
Supply voltage	220-240 VAC 50 ÷ 60 Hz
LED	48-240
Power	18-60 W
Luminous flux	2,501 - 9,180 lm
Power factor	> 0.97
Advisable installation height	Up to 7 m
Weight	2.4 kg, 3.5 kg, 4.5 kg
Lifetime L80B10	> 80,000 h
CCT	4,000 K, optional 5,700 K
CRI	> 80
Photobiological risk	Risk Group 0
SDCM	4
Ingress protection	IP 64 / IP 65
Mechanical strength	IK 09
Surge protection options	1 kV / 2 kV
Operating temperature	-20 °C to +50 °C
Electrical / Appliance class	Class I
Dimming levels	0 - 100 %
Remote control options	DALI or 1-10V
Colour	Silver mat
Housing material	Housing: extruded anodised aluminium Diffuser: extruded PMMA optic
Mounting	Pendant or surface mounting
Warranty	5 years on electronics, 10 years on mechanical parts
Certificates	EN 55015: 2013; EN 61547: 2009; EN 61000-3-2: 2014; EN 61000-3-3: 2013; IEC/EN 60598-1:2014, IEC/EN 60598-2-1:1979 + A1:1987, EN62471:2008, CB, CE

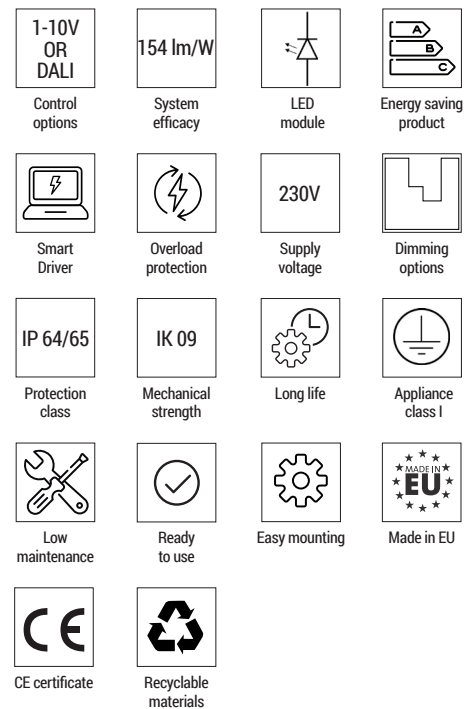

## MAIN FEATURES

Energy efficacy up to 154 lm/W  
Optional build-in motion sensor  
Aluminium housing

## APPLICATIONS

Working stations  
Warehouses and garages

## ACCESSORIES

Motion detector  
Wire mounting bracket

# DIMENSIONS

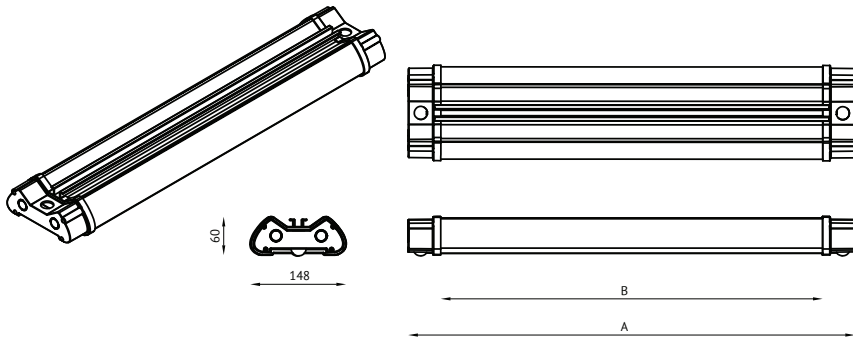

SIZES	60	1200	1500
A	696	1302	1593
B	596	1202	1493
KG	2,4 kg	3,5 kg	4,5 kg

\*All dimensions are in mm.

# OPTIC

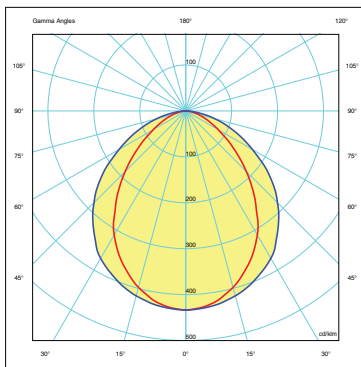

Suitable for industrial facilities with lower mounting heights.

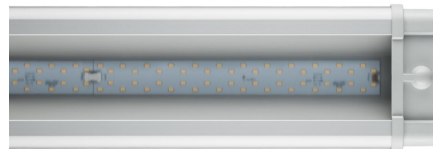

Semi-Transparent diffuser (ST)

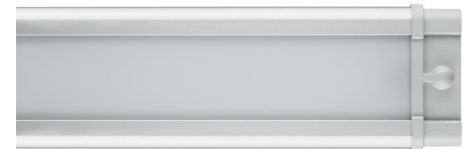

Opal diffuser (OP)

# PRODUCT VARIATIONS

Article	LED	Power [W]	Luminous flux [lm]	Efficacy [lm/W]	Forward current [mA]	Body type	Difusor	Control	Luminaires per fuse	Appliance class	Additional options
GLUM 18.600.OP	96	18	2501	139	60	GLUM A1	Opal	DALI; Programmable; W/O	< 64 pcs	Class I	Motion Detector
GLUM 18.600.ST	96	18	2770	154	60	GLUM A1	Semi-transparent	DALI; Programmable; W/O	< 64 pcs	Class I	Motion Detector
GLUM 36.1200.OP	192	36	5008	139	60	GLUM A2	Opal	DALI; Programmable; W/O	< 45 pcs	Class I	Motion Detector
GLUM 36.1200.ST	192	36	5548	154	60	GLUM A2	Semi-transparent	DALI; Programmable; W/O	< 45 pcs	Class I	Motion Detector
GLUM 53.1500.OP	192	53	7347	139	90	GLUM A3	Opal	DALI; Programmable; W/O	< 32 pcs	Class I	Motion Detector
GLUM 53.1500.ST	192	53	8138	154	90	GLUM A3	Semi-transparent	DALI; Programmable; W/O	< 32 pcs	Class I	Motion Detector
GLUM 60.1500.OP	240	60	8120	135	70	GLUM A3	Opal	DALI; Programmable; W/O	< 32 pcs	Class I	Motion Detector
GLUM 60.1500.ST	240	60	9180	153	70	GLUM A3	Semi-transparent	DALI; Programmable; W/O	< 32 pcs	Class I	Motion Detector

\*Luminous flux is valid for CCT 4000 K

The latest validated data is available at [www.lumenia.com](http://www.lumenia.com).

# G LUM MOUNTING ACCESSORY



Mounting on the ceiling



Mounting on steel wire

# G LUM MOTION DETECTOR

G LUM Motion detector contains a high frequency Doppler Effect module. This module transceives the electromagnetic waves at the 5.8 GHz frequency. As the object moves, the waves reflect back to the module, where detecting happens. A benefit of the radar sensor is that it doesn't use heat differences to detect movement, like the PIR technology, meaning that the sensor can detect any moving object. This feature is great in garage houses, where cars are often cold and the PIR sensor has difficulty detecting them. The sensor is hidden inside the G LUM plastic side cover.

## FUNCTIONAL SPECIFICATIONS

- Detecting any moving object
- Preprogramed dimming levels
- Final settings can be done on field, by setting sensitivity, and ON delay time
- Detection range up to 12 m
- Delay time from 5 seconds to 3 minutes

# Investment in LUMENIA INDUSTRIAL is an efficient decision



**Sustainable  
Environment**



**Energy  
Savings**



**ROI**



**5-year  
Warranty**



**Labour  
Efficiency**



**High  
Performance**

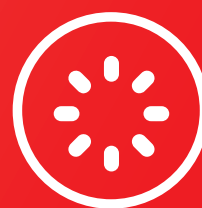

**Dimmable**



**Low  
Maintenance**



**Longer  
Lifetime**



**Designed and  
Manufactured in EU**

